

Lamp Catalogue

BAILEY

ELECTRIC & ELECTRONICS

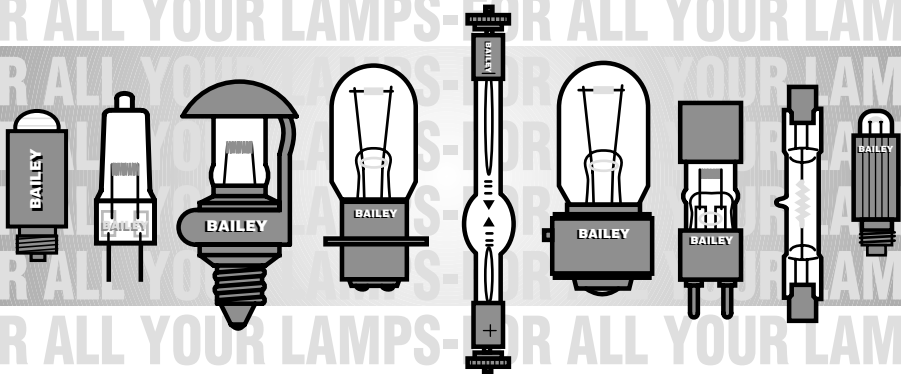

Part 3Z

Medical &
Microscope
lamps



TABLE OF CONTENTS

Page Nr.		Page Nr.		Page Nr.	
ACMI	Z28	HTI	Z12	Riester	Z26
ALM	Z3	Inami	Z11	Rimmer	Z23
American	Z29	Jackson	Z23/25	Scharras	Z25
AMSCO	Z3	Japan	Z29	Silver side mirror	Z33
Amnioscope	Z23	Klinostik	Z27	Skylux	Z10
Anal speculum	Z23	Laryngoscope	Z24/25	Storz	Z23/24/25
Angenieux	Z3	Leitz	Z29	Swift	Z30
Apollon	Z4	Luneau	Z28	Topcon	Z10
Bausch & lomb	Z11/26/30	Martin	Z9	Tuttlinger	Z27
Berchtold	Z5	Mcintosh	Z25	Varifocal	Z28
Boehm	Z27	Microscope lamps	Z29-Z33	Welch Allyn	Z19-Z22
Bronchoscope	Z23	Miller	Z25	Wild	Z30
DKK	Z11	Million	Z10	Wolf	Z25
Dr. Mach	Z8	Morgan	Z27	Zeiss	Z31-Z32
Dr. Saling	Z25	National Electric	Z26		
Effner	Z23/24/26/27	Nikon	Z29		
Endoscopy	Z12-Z14	Oculus	Z26		
Exciter lamps	Z34-Z45	Olympus	Z30		
Foregger	Z25	Ophthalmoscope	Z26/28		
Frenzel	Z23/26	ORC	Z13		
Gallois	Z5	Otoscope	Z27		
Germicioal	Z15	Penlon	Z25		
Gowlland	Z27/28	Pilling	Z23		
Hanalux	Z6-Z7	Protoscope	Z26		
HBO	Z12	Rectoscope	Z27		
Headlights	Z24	Reichart	Z30		
Heine	Z16-Z18	Retinoscope	Z28		

This catalogue has been composed with our full attention and care and we are convinced that it should be correct at the time of printing. However, Bailey Electric & Electronics can never accept any responsibility on descriptions and drawings or any other printing errors.

Also Bailey Electric & Electronics is free to delete or alter lamp types and descriptions.

© Copyright 2000
Bailey Electric & Electronics b.v.

Medical lamps

ALM, Amsco, Angenieux

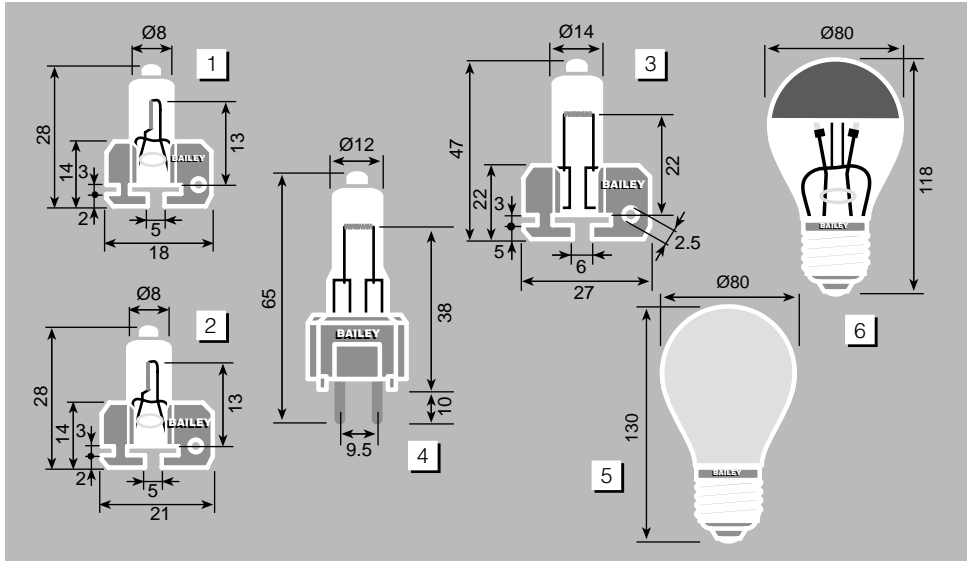

Description	Volt	Watt	Base	Size mm.	Fig. no.	Type number
ALM	24	100	X514	14 x 47	3	MALM 60.232
ALM	24	120	X514	14 x 47	3	MALM 69.50
Amsco	22	220	Gy 9.5	12 x 65	4	MAM 12.93.62.228
Amsco	33	230	Gy 9.5	12 x 65	4	MAM 12.82.49.001
Amsco	24	150	E27	80 x 130	5	MAM 24.150
Amsco	120	150	E27	80 x 118	6	MAM 25.B120
Angenieux	12	100	X511	8 x 28	1	MAN 62.212
Angenieux	24	70	X511	104316 8 x 28	1	MAN 62.21F*
Angenieux	24	70	X511	104316 8 x 28	1	MAN 62.210
Angenieux	24	80	X511	8 x 28	1	MAN 62.211
Angenieux	24	80	X513	8 x 28	2	MAN 62.221
Angenieux	24	100	X511	8 x 28	1	MAN 62.213

* Frosted

Other specifications on request.

Medical lamps

Apollon

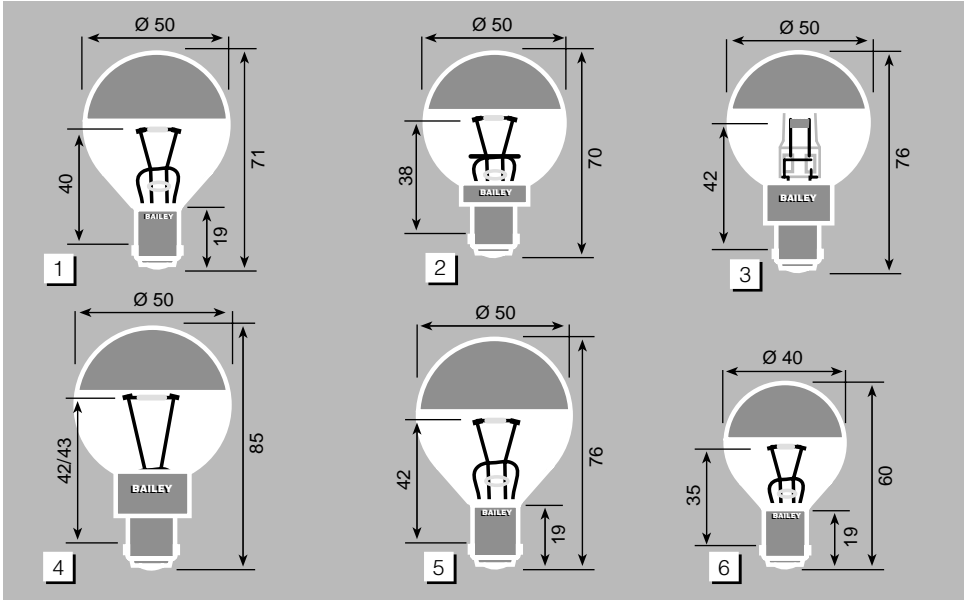

Description	Volt	Watt	Base	Fig. no.	Type number
Apollon	24	30	Ba15d/19	6	MAP 60.04
Apollon	24	35	Ba15d flange halogen	3	MAP 24.35 H
Apollon	24	40	Ba15d flange	2	MAP 01.783 FL
Apollon	24	40	Ba15d/19	1	MAP 59.04
Apollon	24	40	Ba15d	4	MAP 24.40
Apollon	24	50	Ba15d/19	1	MAP 59.05
Apollon	24	50	Ba15d	4	MAP 24.50
Apollon	24	50	Ba15d/19	5	MAP 59.01

Other specifications on request.

Medical lamps

Berchtold chromephare, Gallois

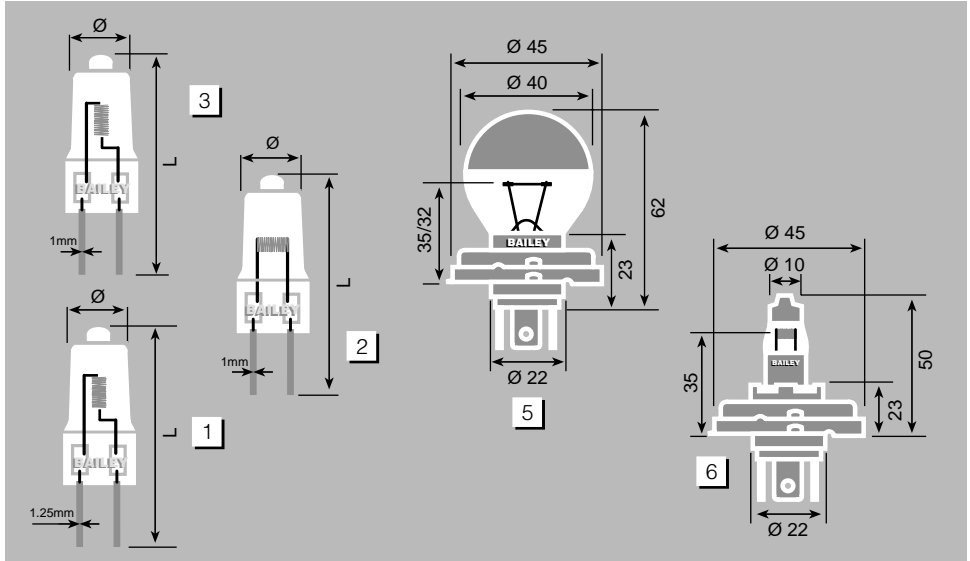

Description	Volt	Watt	Base	Fig. no.	Type number
Berchtold Chromophare	12	35	GY6.35 D200	1	MCZ 94.012
Berchtold Chromophare	12	50	G6.35 D300	2	MCZ 95.512
Berchtold Chromophare	22,8	110	G6.35 C450	3	MCZ 290.522
Berchtold Chromophare	22,8	150	G6.35 C570	2	MCZ 90.624
Berchtold Chromophare	22,8	250	G6.35 C950G	2	MCZ 90.722
Berchtold Chromophare	24	40	G6.35 D200	3	MCZ 94.524
Gallois	12	25	P45T	5	MGA 07.72.G1
Gallois	24	1,4A	P45T	5	MGA 07.72.G4
Gallois	24	1,4A	P45T L 99	5	MGA 97.72.L3
Gallois	24	21	P45T	6	MGA 58.911
Gallois	24	25	P45T	6	MGA 58.911 A
Gallois	24	35	P45T	6	MGA 58.911 B
Gallois	24	50	P45T	6	MGA 58.912
Gallois	24	55	P45T	6	MGA 58.913

Other specifications on request.

Medical lamps Hanaulux equivalents

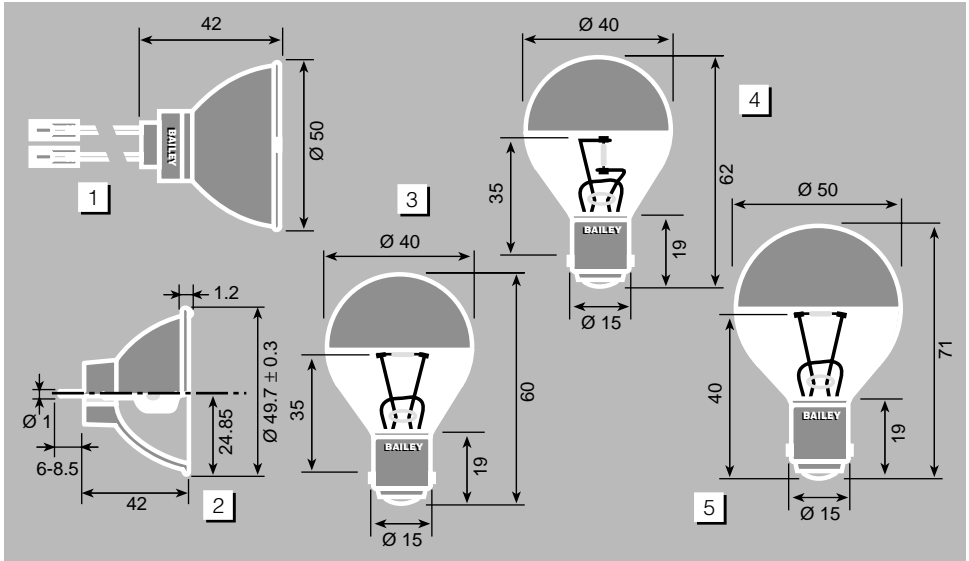

Description	Volt	Watt	Base	Fig. no.	Type number
Hanaulux	12	25	Ba15d/19	3	MH 016.191
Hanaulux	12	40	Ba15d/19	3	MH 016.193
Hanaulux	12	100	GZ6.35	1	MH 004.653
Hanaulux	12	100	GZ6.35	2	MH 018.565
Hanaulux	15	150	GZ6.35	2	MH 018.869
Hanaulux	24	25	Ba15d/19	3	MH 016.164
Hanaulux	24	25	Ba15d/27x17	3	MH 016.322
Hanaulux	24	40	Ba15d/24x17	3	MH 016.372
Hanaulux	24	40	Ba15d/19	4 axial	MH 018.550
Hanaulux	32	40	Ba15d/19	3	MH 016.579
Hanaulux	50	30	Ba15d/19	3	MH 018.505
Hanaulux	110	30	Ba15d/19	3	MH 016.170
Hanaulux	115	30	Ba15d/19	3	MH 016.237
Hanaulux	115	30	Ba15d/24x17	3	MH 016.526
Hanaulux	120	30	Ba15d/19	5	MH 016.344
Hanaulux	120	40	Ba15d/24x17	3	MH 016.435
Hanaulux	125	30	Ba15d/19	3	MH 016.238

Other specifications on request.

Medical lamps

Hanaulux equivalents

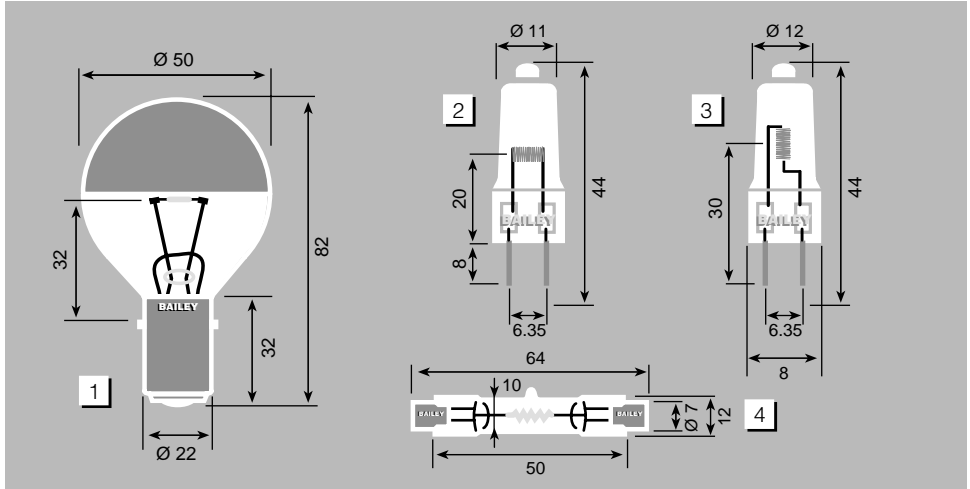

Description	Volt	Watt	Base	Fig. no.	Type number
Hanaulux	22,8	40	G6.35	2	MH 018.769
Hanaulux	22,8	50	G6.35	2	MH 018.566
Hanaulux	22,8	50	G6.35	3 axial	MH 015.282
Hanaulux	22,8	75	R7s	4	MH 018.366
Hanaulux	24	40	BX22d/32	1	MH 016.544
Hanaulux	24	40	BX22d/32	1 frosted	MH 018.306
Hanaulux	24	50	BX22d/32	1	MH 016.678
Hanaulux	24	50	G6.35	2	MH 018.576
Hanaulux	32	50	BX22d/32	1	MH 016.813
Hanaulux	50	50	BX22d/32	1	MH 016.685
Hanaulux	110	50	BX22d/32	1	MH 016.679
Hanaulux	110	50	BX22d/32	1 frosted (019190)	MH 016.423
Hanaulux	120	50	BX22d/32	1	MH 018.190
Hanaulux	125	50	BX22d/32	1	MH 016.578
Hanaulux	220-230	50	BX22d/32	1 frosted (019188)	MH 018.250
Hanaulux	220-230	50	BX22d/32	1	MH 018.251
Hanaulux	240-250	50	BX22d/32	1	MH 018.253
Hanaulux	240-250	50	BX22d/32	1 frosted (019189)	MH 018.252

Other specifications on request.

Medical lamps

Dr. Mach

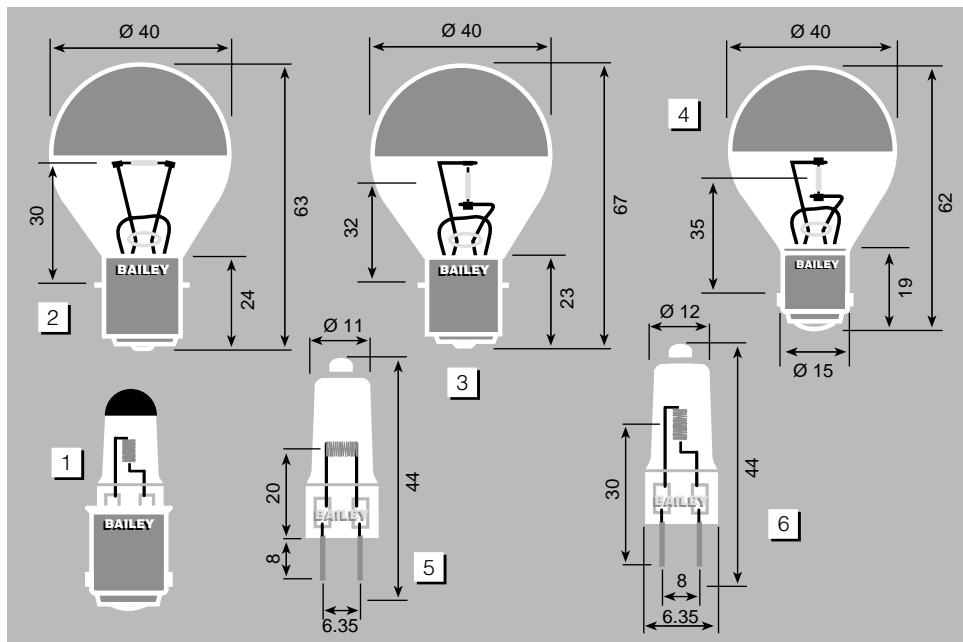

Description	Volt	Watt	Base	Fig. no.	Type number
-------------	------	------	------	----------	-------------

Dr. Mach	12	35	Ba15d/19	4 axial	MMA 14.50
Dr. Mach	24	25	Ba20d	2	MMA 15.90
Dr. Mach	24	40	Ba15d	4 axial	MMA 12.10
Dr. Mach	24	40 halogen	Ba15d black top	1 axial	MMA 12.10 H
Dr. Mach	24	50 halogen	G6.35	5	MMA 23.50
Dr. Mach	24	55 halogen	G6.35	6 axial	MMA 16.60
Dr. Mach	24	60 halogen	Ba20d	3 axial	MMA 11.50

Other specifications on request.

Medical lamps

Martin

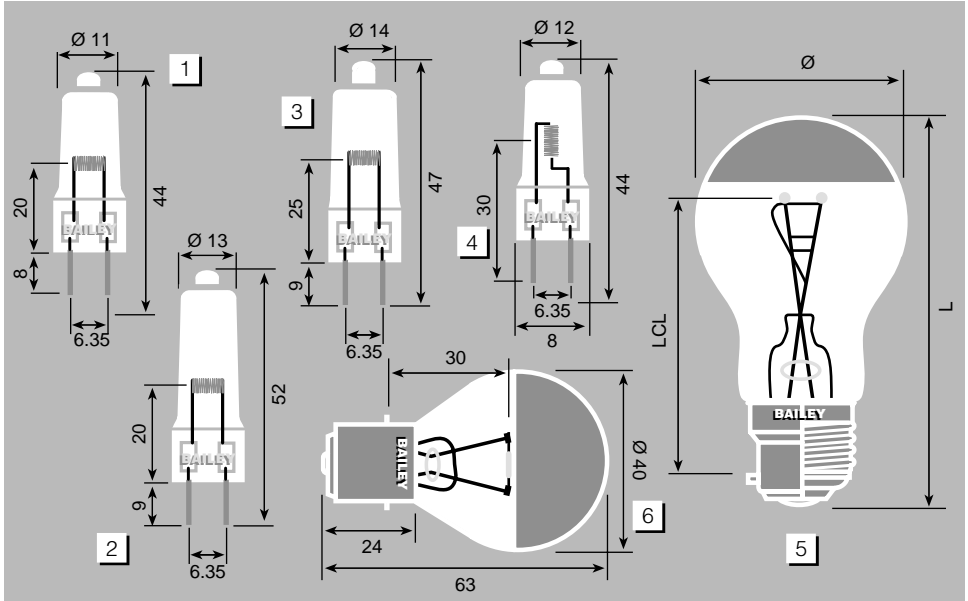

Description	Volt	Watt	Base	Dim.	LCL.	Fig. no.	Type number
Martin	24	25	Ba20d	585E		6	MM 88.91.602
Martin	24	50	Ba20d			6	MM 88.91.604
Martin	24	50/50	Ba22d	80x126	80	5	MM 88.91.402
Martin	24	55	G6.35	C300		3	MM 86.90.300
Martin	24	60	Ba20d			6 axial	MM 15.21
Martin	24	75/75	E27	80x150	110	5 frosted	MM 88.91.202
Martin	24	100	G6.35	C450		1	MM 88.90.524
Martin	24	100/100	E27	80x170	130	5	MM 88.91.002
Martin	24	120	G6.35			4	MM 86.90.500
Martin	24	150	G6.35	C571		2	MM 88.90.624
Martin	24	250	GY6.35			2	MM 86.91.000
Martin	24	250	G6.35	C950		4	MM 88.90.724

Other specifications on request.

Medical lamps Million, Skylux, Topcon

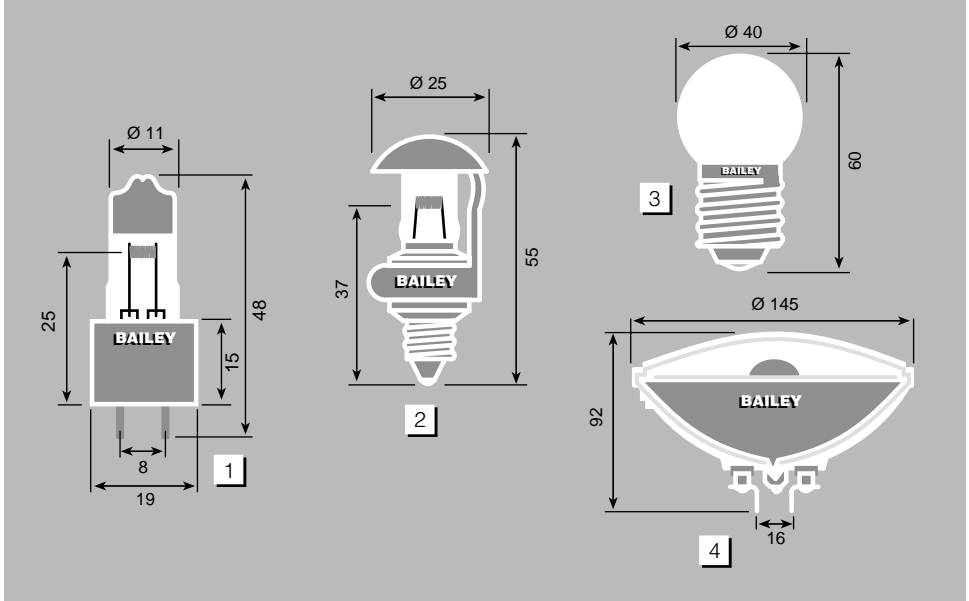

Description	Volt	Watt	Base	Fig. no.	Type number
Million	24	40	G8 black top	1	MMI 67.04 TN
Million	24	50	G8 frosted top	1	MMI 67.04 TS
Skylux	24	35	E11 SH37	2	MSH 37
Skylux	24	40	E11 SH42	2	MSH 42
Skylux	24	50	E11 SH52	2	MSH 52
Skylux	24	40	G16	4	MSHCR 14.53 B
Skylux	24	40	G16	4	MSHCR 15.03 S
Topcon	230	15	E27 clear for lensmeters	3	MTO 10.14
Topcon	230	15	E27 frosted for lensmeters	3	MTO 10.15 F

Other specifications on request.

Medical lamps

Bausch & Lomb, DKK, Inami

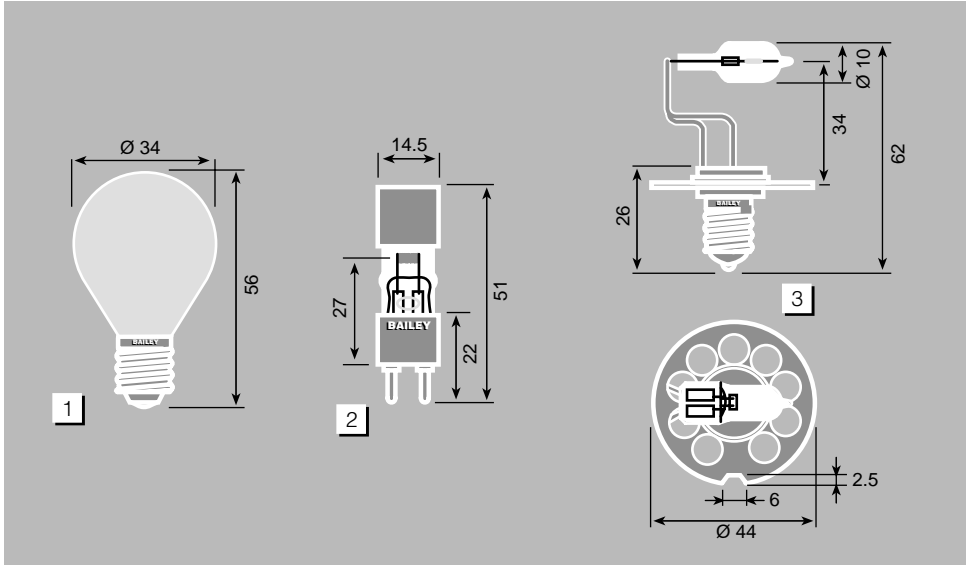

Description	Volt	Watt	Amp.	Base	Fig. no.	Type number
Bausch & Lomb	130	30		E12	1	MBL 31.307
DKK	24	50		G8	2	MDKK 24.501
Inami	12	50	4,2	P44S	3	MIN 21.58 H



Other specifications on request.

Medical lamps

Endoscopy, Metal halide

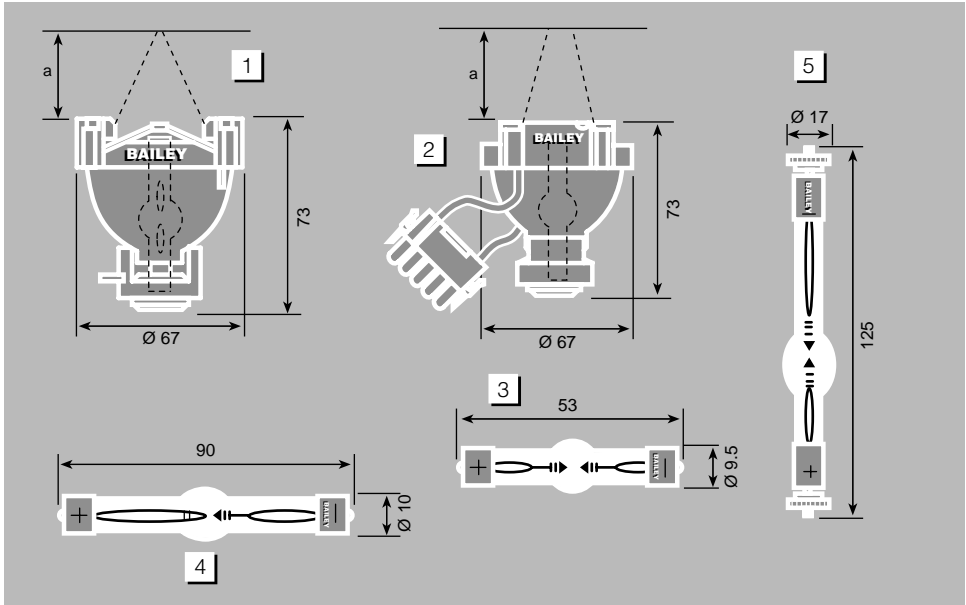

Description	Volt	Watt	Life	Fig. no.	Im	Type number	
Endoscopy	45	270	250	1	a=22	HTI 250.22	
Endoscopy	45	270	250	1	a=32	HTI 250.32	
Endoscopy	45	270	250	2	a=32	HTI 250.32 C	
Endoscopy	55	400	250	2	a=24	HTI 403.24	
HBO	DC	22	50	200	3	1.300	SAM 503
HBO	AC	39-45	50	100	3	2.000	SAM 50ACL1
HBO	AC	34-39	50	100	3	2.000	SAM 50ACL2
HBO	DC	20	100	200	4	2.500	SAM 1002
HBO	AC/DC	61/53	3,6 A	200	5	10.000	SAM 2002L1
HBO	AC/DC	61/53	4,2 A	200	5	10.000	SAM 2002L2
HBO	DC	57	3,5 A	200	5	10.000	SAM 200DC
HBO	DC	61	3,6 A	200	5	9.500	SAM 2004

Other specifications on request.



Medical lamps

ORC, Endoscopy

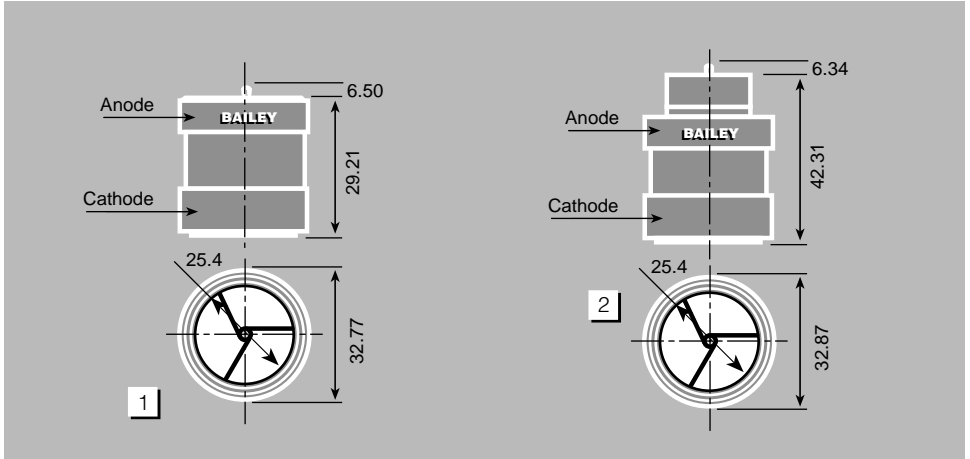

Description	Volt	Watt	Amp.	Ign. Volt	Life	Fig. no.	Type number
ORC	12	150	13	23K	500	1	MORC 150 F
ORC	12	150	13	23K	500	1	MORC 150 UV
ORC	14	175	21	23K	500	2	MORC 175 F
ORC	14	175	21	23K	500	2	MORC 175 UV
ORC	14	300	21	23K	500	2	MORC 300 F
ORC	14	300	21	23K	500	2	MORC 300 UV
ORC	14	300	21	23K	500	2	MORC 300 FP
ORC	14	300	21	23K	500	2	MORC 1052*
ORC	14	300	21	23K	500	2	MORC 1064*
ORC	14	300	21	23K	500	2	MORC 1064 S*

* Kit includes timer, diffuser screen and thermal compound

P= Pulse lamp

Other specifications on request.

Medical lamps

ORC Cross reference

3D Scope	300W Xenon	MORC 300 F
Acufex	FRX300 Xenon	MORC 300 F
Acuity	A09501/A09502 Ultralife #013845	MORC 300 F
ALM MTA	Starpointe XE	MORC 300 F
ACMI/Circon	ALV-1, MV-9086 & MV-9087	MORC 300 F
Applied Fiberoptics	Brite Lite III	MORC 300 F
Baxter/V. Mueller	OP SIS VS5500	MORC 300 F
Baxter/V. Mueller	OP SIS VS5600	MORC 300 F
Baxter/Edwards	OPTX300	MORC 300 F
BEI/Xylog	300W Xenon	MORC 300 F
Cabot Medical	System 3000	MORC 300 F
Circon/ACMI	ALV-1 and MV-9086	MORC 300 F
Cooper Surgical	Endomed LSS700	MORC 300 F
Dyonics (Smith & Nephew)	Dyo-Bright 3000XE	MORC 300 F
Endo Image	300W Xenon	MORC 300 F
Endolap	S605-25	MORC 300 F
Endomedics	S1500	MORC 300 F
FPO (Fujinon)	EPX302 Y1072/Y1089/XL401	MORC 300 F
Fuji	FLX2000	MORC 300 F
Kay	Swallowing Workstation	MORC 300 F
ILC	Y1153	MORC 300 F
Linovatec	300W Xenon 8170	MORC 300 F
Luxtac	7000 (300W)	MORC 300 F
Luxtac	9000/9300 (300W)	MORC 300 F
Luxtac	1900 (150W) "Y1144"	MORC 150 F
Luxtac	9175	MORC 175 F
Medical Dynamics	6100XE	MORC 300 F
Misc.	Y1153	MORC 300 F
Mist	300W Xenon	MORC 300 F
Nextec	300W Xenon	MORC 300 F
Olympus	CLV10	MORC 1052
Olympus	CLVF10	MORC 1064
Olympus	CLVU20	MORC 1064 S
Olympus	ILX6300	MORC 1052
Olympus	ILX/CLS/ILV/CLV-A (300W)	MORC 1052
Olympus	XLS (175W) Y1176 or CLV-A (175W)	MORC 175 F
Olympus	CLVS20	MORC 1052
Olympus	CLVU40	MORC 1064 S
Olympus	CLVS	MORC 1064 S
Origin Medical	300W Xenon	MORC 300 F
ORC	ORC6000, CIA, CIT, CIS, CIW, 5800 & 5800E	MORC 300 F
Pentax	Video Processor OLX4 EMP3000	MORC 300 F
Pilling	300W Xenon	MORC 300 F
Snowden Pencer	Xenon L/S 300W	MORC 300 F
Storz	610	MORC 300 F
Storz	611	MORC 300 FP
Storz	615 B or C Model; Lamp is designated as 615 XE; lampholder is 615XES	MORC 175 F
Storz	630	MORC 300 FP
Storz	300 (20133020) 20133206 Lamp only	MORC 300 F
Storz	487C	MORC 300 F
Tagarno	35AX ACUBEAM	MORC 300 F
Vanguard	XR-350	MORC 300 F
Vanguard	XR-35	MORC 300 F
Vanguard	XR-300	MORC 300 F
Video Dynamics	XLC-300	MORC 300 F
Weck	WECKLITE300	MORC 300 F
Wolf	300W Xenon	MORC 300 F
Woodbine/Solos	ELS2	MORC 175
Woodbine/Solos	GS9255	MORC 300 F
Woodbine/Solos	GS9205	MORC 300 F
Zeiss	SUPERLUX 300	MORC 300 F
Zeiss	SUPERLUX 175 (Y1308)	MORC 175 F

Other specifications on request.



Medical lamps

Compact and fluorescent tubes

Germicidal lamps

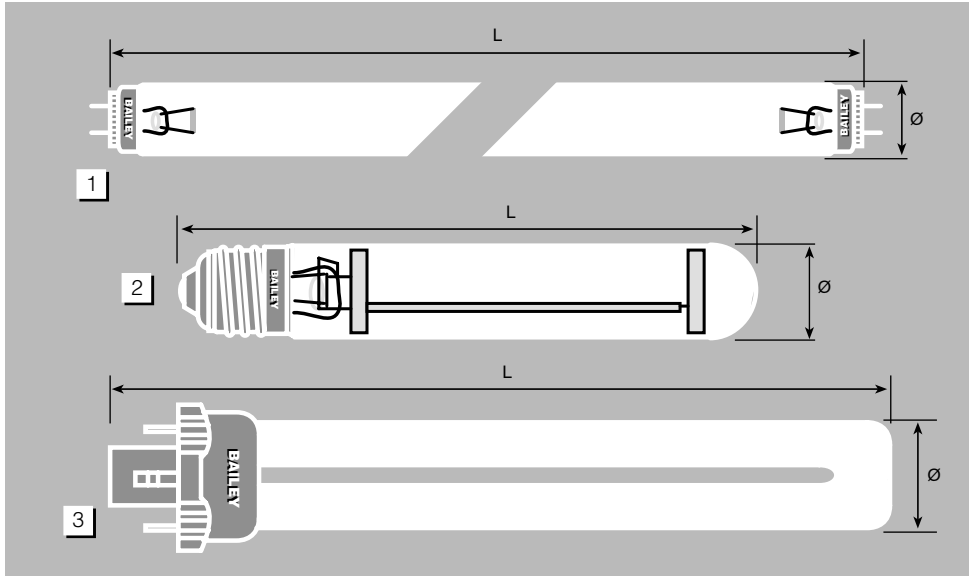









Volt	Watt	Size	Base	Fig. no.	Type number
29	4	16x150	G5	1	FT 004 GERM
42	6	16x226	G5	1	FT 006 GERM
56	8	16X300	G5	1	FT 008 GERM
55	10	25x330	G13	1	FT 010 GERM
56	15	26X440	G13	1	FT 015 GERM
100	30	26X900	G13	1	FT 030 GERM
105	36	26X1200	G13	1	FT 036 GERM
83	55	28X900	G13	1	FT 055 GERM
108	75	28X1200	G13	1	FT 075 GERM
92	115	38X1200	G13	1	FT 115 GERM
220	6	26x150	E27	2	FTC 06 GERM27
Ballast	10	25x221	E27	2	FTC 10 GERM27
60	9	28x168	G23	3	FTC 09 GERM23
91	11	28x238	G23	3	FTC 11 GERM23

Other specifications on request.

Medical lamps

Heine equivalents









Descript.		Volt	Type number	
Heine	2,5	Otoscope	MHX 01.88.037	
Heine	3,8	old model	MHX 02.88.049	
Heine	2,5	Straight laryngeal mirror	MHX 01.88.057	
Heine	3,8	mirror	MHX 02.88.063	
Heine	2,5	Autofoc examination light	MHX 01.88.032 HA	
Heine	3,5		MHX 02.88.047 HA	
Heine	2,5	Alpha episcopes	MHX 01.88.034 HA	
Heine	2,5	Glauco test, F.O.	MHX 01.88.035 KR	
Heine	2,5	Laryng. finoff illum.	MHX 01.88.035 HA	
Heine	3,5	Amniosc.	MHX 02.88.044 HA	
Heine	2,5	Alpha otoscope	MHX 01.88.037	
Heine	2,5		MHX 01.88.037 KR	
Heine	2,5		MHX 01.88.037 HA	
Heine	3,5		MHX 02.88.049	
Heine	3,5		MHX 02.88.049 KR	
Heine	3,5		MHX 02.88.049 HA	
Heine	2,5	HFR 2-Fleck-Skiascope	MHX 01.88.038 HA	
Heine	3,5	(verkl. Darst./red. scale)	MHX 02.88.046 HA	
Heine	2,5	Focalux	MHX 01.88.039 HA	
Heine	3,5		MHX 02.88.091 HA	
Heine	2,5	Protoscope with proximale illumination	MHX 01.88.040 KR	
Heine	2,5		MHX 01.88.040 HA	
Heine	3,5		MHX 02.88.051 HA	

KR=Krypton HA=Halogen

Other specifications on request.

Medical lamps

Heine equivalents









	Descript. Volt		Type number
	Heine	2,5 Mini fibrilux,	MHX 01.88.041
	Heine	2,5 mini 2000	MHX 01.88.041 KR
	Heine	2,5 combilight + cliplight	MHX 01.88.041 HA
	Heine	2,5 Ophthalmoscope, mini	MHX 01.88.042 KR
	Heine	2,5 microflex + focalux	MHX 01.88.042 HA
	Heine	2,5 Alpha examination light	MHX 01.88.043 HA
	Heine	2,5 Minilux, otoscope,	MHX 01.88.056 KR
	Heine	2,5 mini 2000 otoscope	MHX 01.88.056 HA
	Heine	2,5 Straight laryngeal	MHX 01.88.057 KR
	Heine	2,5 mirror	MHX 01.88.057 HA
	Heine	3,5	MHX 02.88.063 HA
	Heine	2,5 HSR2 retinoscope	MHX 01.88.058 HA
	Heine	3,5	MHX 02.88.048 HA
	Heine	2,5 Laryngoscope	MHX 01.88.059
	Heine	2,5	MHX 01.88.059 KR
	Heine	2,5	MHX 01.88.059 HA
	Heine	2,5 Beta 200	MHX 01.88.069 HA
	Heine	3,5 ophthalmoscope	MHX 02.88.070 HA
	Heine	2,5 Diverse otoscope	MHX 01.88.077 HA
	Heine	3,5	MHX 02.88.078 HA

Other specifications on request.

KR=Krypton HA=Halogen

Medical lamps

Heine equivalents









Descript.		Volt		Type number	
Heine	2,5	Beta 200		MHX 01.88.087 HA	
Heine	3,5	retinoscope		MHX 02.88.089 HA	
Heine	2,5	Beta 200		MHX 01.88.088 HA	
Heine	3,5	retinoscope		MHX 02.88.090 HA	
Heine	3,5	Indirect		MHX 02.88.050 HA	
Heine	6,0	handophthalm.		MHX 04.88.081 HA	
Heine	6,0	Lighthandle		MHX 04.88.060 HA	
Heine	6,0	Omega 100-150-200		MHX 04.88.068 HA	
		headlight SL350			
Heine	6,0	Sigma 100 indirect		MHX 04.88.076 HA	
Heine	6,0	UBL100		MHX 04.88.080 HA	
Heine 104	2,5	Rectoscope bulbs		MFA 99.28.525	
Heine 104	4,0			MFA 99.28.540	
Heine	2,5	old model 41A		MFA 99.10.125	
Heine	3,8	otoscope bulbs		MFA 99.10.138	

HA=Halogen

Other specifications on request.

Medical lamps

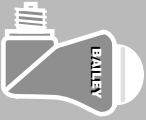
Welch Allyn equivalents

	Descript.	Volt	Type number
	Welch Allyn Welch Allyn	2,5 2,5	Laryngoscope clear for children frosted MWA 00.100 1A MWA 00.100 1AF
	Welch Allyn	2,5	Some otoscopes, anosc. laryngoscopes for adults MWA 00.200
	Welch Allyn	2,5	Otoscope old model MWA 00.400
	Welch Allyn	2,5	Sigmoidoscope 30800 MWA 00.600
	Welch Allyn	2,5	Ophthalmoscope and Retinoscope 10600 121, 110, 17600, 17610 MWA 00.900
	Welch Allyn	2,5	Transilluminator 43200, 43000 MWA 01.000
	Welch Allyn	2,5	Transilluminator 43100 MWA 01.100
without picture	Welch Allyn	4,65	Bio MWA 01.200 HA
	Welch Allyn	2,5	Tongue blade holder Penlites 28000, 76000, 77700 MWA 01.300
	Welch Allyn	2,5	Penlite 77800 MWA 01.400

Other specifications on request.

HA=Halogen

Medical lamps

Welch Allyn equivalents











Descript.	Volt	Type number	
Welch Allyn	2,5	Retinoscope 17700	MWA 01.800
Welch Allyn	7,0	Headlight 45003 (verkl. Darst./red. scale)	MWA 02.000
Welch Allyn	2,5	Ophthalmoscope 11500	MWA 02.100
Welch Allyn	2,5	Otoscope 22900	MWA 02.200
Welch Allyn	2,5	Ophthalmoscope 12900	MWA 02.300
Welch Allyn	6,0	Headlight 46003 (verkl. Darst./red. scale)	MWA 02.500
Welch Allyn	6,0	Headlight 46003	MWA 02.600
Welch Allyn	2,5	Otoscope 24020	MWA 02.700
Welch Allyn	3,5	Ophthalmoscope, episcopes, strabismoscope retinoscope 11710, 12400, 47300, 11600, 11605, 11610	MWA 03.000 HA
Welch Allyn	3,5	Otosopes, illuminators 21110, 24031, 24011, 24020, 24000, 27200 etc.	MWA 03.100 HA

HA=Halogen

Other specifications on request.

Medical lamps

Welch Allyn equivalents









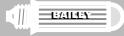

	Descript.	Volt	Type number
	Welch Allyn	2,5	Ophthalmoscopes
	Welch Allyn	2,5	11511, 11500
			MWA 03.300
			MWA 03.300 HA
	Welch Allyn	2,5	Otoscope, illuminators
	Welch Allyn	2,5	21110, 24031, 24022 24000, 27200 etc.
			MWA 03.400 KR
			MWA 03.400 HA
	Welch Allyn	2,5	Laryngoscope, illuminator 60500
			MWA 03.600
	Welch Allyn	3,5	Retinoscope 18100
			MWA 03.700
	Welch Allyn	2,5	Ophthalmoscopes
	Welch Allyn	2,5	12810, 11110
	Welch Allyn	2,5	
			MWA 03.900
			MWA 03.900 KR
			MWA 03.900 HA
	Welch Allyn	2,5	Ophthalmoscopes
	Welch Allyn	2,5	11400
			MWA 04.300
			MWA 04.300 KR
	Welch Allyn	14,5	Examination lights 48400,48410
			MWA 04.100
	Welch Allyn	2,5	Ophthalmoscopes
	Welch Allyn	2,5	11470, 11475, 11400 11411
			MWA 04.400 KR
			MWA 04.400 HA
	Welch Allyn	3,5	Retinoscope 18010
			MWA 04.500 HA
	Welch Allyn	3,5	Retinoscope 17710
			MWA 04.600 HA

Other specifications on request.

KR=Krypton HA=Halogen

Medical lamps

Welch Allyn equivalents







Descript.	Volt	Type number	
Welch Allyn	2,5	Laryngoscopes for children 634, 664, 674, 680, 684, 690, 692, 694	MWA 04.700 
Welch Allyn	2,5	Laryngoscopes for adults 634, 640, 664, 674, 680, 684, 690, 692, 694, 40415	MWA 04.800 
Welch Allyn	3,5	Ophthalmoscopes 11720 11730, 11620, 11630	MWA 04.900 HA 
Welch Allyn Welch Allyn	2,5 2,5	Laryngoscope handles 60813, 60814, 60715, 60815, 60803, 60804	MWA 06.000 KR MWA 06.000 HA 
Welch Allyn	14,5	Examination lights 48435	MWA 06.100 HA 
Welch Allyn	3,5	Audioscopes 23300, 23000, 23020, 23040	MWA 06.200 HA 
Welch Allyn	2,5	Retinoscope 17200	MWA 07.200 HA 
Welch Allyn	6,0	Handles of: Anoscope, vaginalspeculum, sigmoidoscope	MWA 07.800 
Welch Allyn	2,5	Penlite 76600	MWA 07.600 HA 
Welch Allyn	3,5	Retinoscope 18200	MWA 08.200 HA 
Welch Allyn	3,5	Retinoscope 18300	MWA 08.300 HA 

KR=Krypton HA=Halogen

Other specifications on request.

Medical lamps

Amnioscope, Anal speculum, Bronchoscope, Frenzel

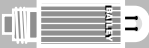
	Descript.	Volt		Type number
	Effner E655	4,0	Amnioscopes old model	MFA 99.181
	Effner E656	4,0	Amnioscopes new model	MFA 99.182
	Effner 168+44D	2,7	Anal speculum	MFA 99.01.127
	Effner 168+44D	2,7	Anal speculum	MFA 99.81.127 KR
	Effner 168+44D	3,8	Anal speculum	MFA 99.01.138
	Effner 168+44D	3,8	Anal speculum	MFA 99.91.138 HA
	Jackson 62	4,0	Bronchoscope	MFA 99.232
	Storz/Negus 63	4,0	Bronchoscope	MFA 99.233
	Rimmer 8 BA	2,5	Bronchoscope	MER 5
	Effner	8-10	Diaphanoscope	MFA 99.014
	Frenzel	3,8	Frenzel spectacles	MEM 68

Other specifications on request.

KR=Krypton HA=Halogen

Medical lamps

Headlights, Laryngoscope











Descript.	Volt		Type number	
Effner 709+56T	4,0	Headlights	MFA 99.01.240	
Effner 709+56T	6,0	Headlights	MFA 99.01.260	
Effner 709+56T	8-10	Headlights	MFA 99.01.210	
Effner	8-10	Headlights	MFA 99.015	
Storz E82	6,0	Headlights	MFA 99.433	
Storz E83	6,0	Headlights	MFA 99.434	
Effner 167 + 45D	2,5	Laryng mirrors/ /inspection lamps	MFA 99.00.225	
Effner 167 + 45D	2,5	Laryng mirrors/ inspection lamps	MFA 99.80.225 KR	
Effner 167 + 45D	3,8	Laryng mirrors/ inspection lamps	MFA 99.00.238	
Effner 167 + 45D	3,8	Laryng mirrors/ inspection lamps	MFA 99.80.238 HA	
Effner 39H	2,7	Laryng mirrors/ inspection lamps	MFA 99.00.327	
Effner 39H	4,0	Laryng mirrors/ inspection lamps	MFA 99.00.340	
Effner 168 + 44D	2,7	Laryng mirrors/ inspection lamps	MFA 99.01.127	
Effner 168 + 44D	3,8	Laryng mirrors/ inspection lamps	MFA 99.01.138	

KR=Krypton HA=Halogen

Other specifications on request.

Medical lamps

Laryngoscope

	Descript.	Volt		Type number
	Dr Saling 623	2,5	Laryngoscope	MFA 99.006
	Storz 101	2,5	Laryngoscope for children	MFA 99.051
	Miller	2,5	Laryngoscope	MFA 99.166.01*
	Foregger	2,5		MFA 99.166.02
	McIntosh ring	2,5		MFA 99.167*
	McIntosh	2,5		MFA 99.168*
	spring contact McIntosh, ring +spring contact	2,5		MFA 99.169*
	Miller	2,7	Laryngoscope	MFA 99.064*
	Foregger	2,7		MFA 99.064.01*
	McIntosh			
	McIntosh	2,7	Laryngoscope	MFA 99.05.201
	McIntosh	2,7		MFA 99.05.202*
	McIntosh ring	2,7		MFA 99.05.203
	McIntosh ring	2,7		MFA 99.05.204*
	McIntosh ring +spring contact	2,7	Laryngoscope	MFA 99.171*
	McIntosh	2,7		MFA 99.172*
	+springcontact			
	McIntosh ring	2,7		MFA 99.173*
	McIntosh	2,7		MFA 99.174*
	McIntosh	2,7		MFA 99.959 HA*
	Penlon	2,7	Laryngoscope	MFA 99.057
	Penlon+ring	2,7		MFA 99.058
	Jackson	3,8	Laryngoscope	MFA 99.068
	Wolf-Effner-Henke SASS.F.O. Handle	2,5	Laryngoscope	MFA 99.904 HA
	Scharras type		Laryngoscope	MEM 169

2,5V + 2,7V Laryngoscope bulbs available with krypton gas on request

Medical lamps

Ophthalmoscope, Proctoscope









Descript.	Volt	Type number	
Effner-May 167A	2,7	Ophthalmoscope	MFA 99.004
Effner-May 167A	2,5		MFA 85.125 KR
Effner-May 167A	3,8		MFA 85.138 HA
Effner-Focuba 167B	2,7	Ophthalmoscope	MFA 99.005
Effner-Focuba 167B	2,7		MFA 99.805 KR
Riester-May 10424	2,5	Ophthalmoscope	MFA 99.00.45
Oculus	4,0	Ophthalmoscope	MFA 99.15.440
Oculus	6,0		MFA 99.15.460
Oculus	9,0		MFA 99.15.490
Frenzel 68	3,8	Ophthalmoscope	MFA 99.155
Frenzel 68	3,8		MFA 99.855 HA
Bausch & Lomb BL44	2,5	Ophthalmoscope	MFA 99.159
National Electric N33B	2,5	Ophthalmoscope	MFA 99.160
Effner 412	2,5	Proctoscope	MFA 99.32.225
Effner 412	3,8		MFA 99.32.238
Effner 426	2,5	Proctoscope	MFA 99.01.025
Effner 426	2,5		MFA 99.81.025 KR
Effner 426	3,8		MFA 99.01.038
Effner 426	3,8		MFA 99.81.038 HA

KR=Krypton HA=Halogen

Other specifications on request.

Medical lamps

Otoscope, Rectoscope

	Descript.	Volt		Type number
	Effner 43C + 166	2,5	Otoscope	MFA 99.001
	Effner 43C	2,5	Otoscope	MFA 99.801 KR
	Effner 43C + 166	3,8	Otoscope	MFA 99.00.138
	Effner 43C	3,8	Otoscope	MFA 99.80.138 HA
	Tuttlinger 42B	2,7	Otoscope	MFA 99.10.227
	Tuttlinger 42B	2,7	Otoscope	MFA 99.80.227 KR
	Tuttlinger 42B	3,8	Otoscope	MFA 99.10.238
	Tuttlinger 42B	3,8	Otoscope	MFA 99.80.238 HA
	Gowland #12	2,5	Otoscope	MFA 99.113
	Gowland #12	2,5	Otoscope	MFA 99.813 KR
	Riester UNI I 10421	2,7	Otoscope	MFA 99.114
	Riester UNI I 10421	2,7	Otoscope	MFA 99.814 KR
	Boehm	2,5	Otoscope	MEB 5
	Boehm	4,0	Otoscope	MEB 6
	Riester 3900	2,7	Otoscope	MEM 114
	Effner 40B	2,7	Rectoscope	MFA 99.00.927
	Effner 40B	4,0	Rectoscope	MFA 99.009
	Klinostik K7	3,5	Rectoscope	MFA 99.29.235
	Morgan A24	3,5	Rectoscope	MFA 99.325

Other specifications on request.

KR=Krypton HA=Halogen

Medical lamps

Retinoscope, Ophthalmoscope

Descript.	Volt	Type number	
Luneau 14.48.94	3,7	Retinoscope	MEM 61.20
ACMI AC 34	2,5	Ophthalmoscope	MFA 99.161
ACMI AC35	3,5	Ophthalmoscope	MFA 99.162
Gowlland G3	2,5	Ophthalmoscope	MFA 99.163
Varifocal 100 Varifocal 100	2,5 2,5	Ophthalmoscope Ophthalmoscope	MFA 99.184 MFA 99.884 KR
Luneau Luneau 12.36.76	2,5 3,8	Ophthalmoscope Ophthalmoscope	MEM 10.15 MEM 10.19
Luneau E10	3,8	Ophthalmoscope	MEM 10.20

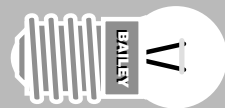
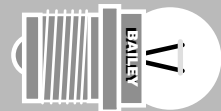
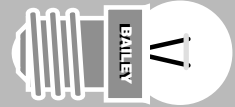



Microscope lamps

American, Japan, Leitz, Nikon

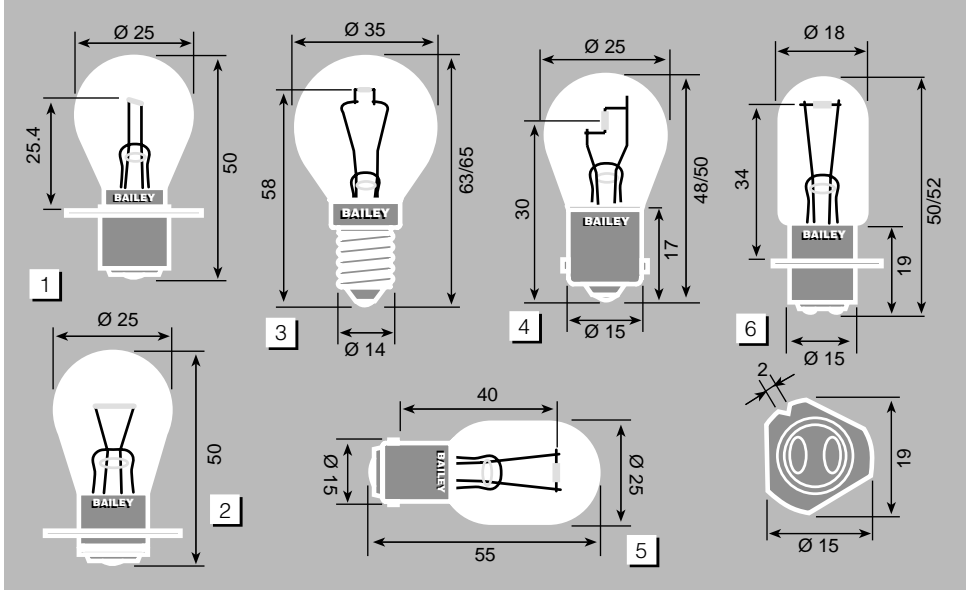

Description	Volt	Amp.		Base	Life	Fig. no.	Type number
American	6	4,5	1096X C-6R	P30d	500	1	MOP 22.20 X
American	6,5	2,75	1631X C-6U	P30d	100	1	MOP 22.00 X
American	6,5	2,75	1649 FC-6Z	P30d	100	1	MOP 22.10
American	7	35 W	FC-8Z	P30d	100	1	MOP 22.35
Japan	6	3		P30s	100	2	MO 31.02
Japan	6	33 W		P30s	80	2	MGU 17.621
Japan	10	1,5		P30s	200	2	MOP 24.31
Japan	12	25 W		P30s	600	2 Axial	MGU 17.62 AX
Leitz	6	4,5	8001	E14/16	100	3	MLT 61.00.25
Leitz	12	25 W	7582	Ba15s	600	4	MLT 05.05.35
Nikon	6	15 W		P25d	100	6	MNI 77.903
Nikon	6	30 W	2118 Swift MA738	Ba15d	200	5	MNI 77.904

Other specifications on request.

Microscope lamps

Olympus, Reichart, Swift, B & L, Wild

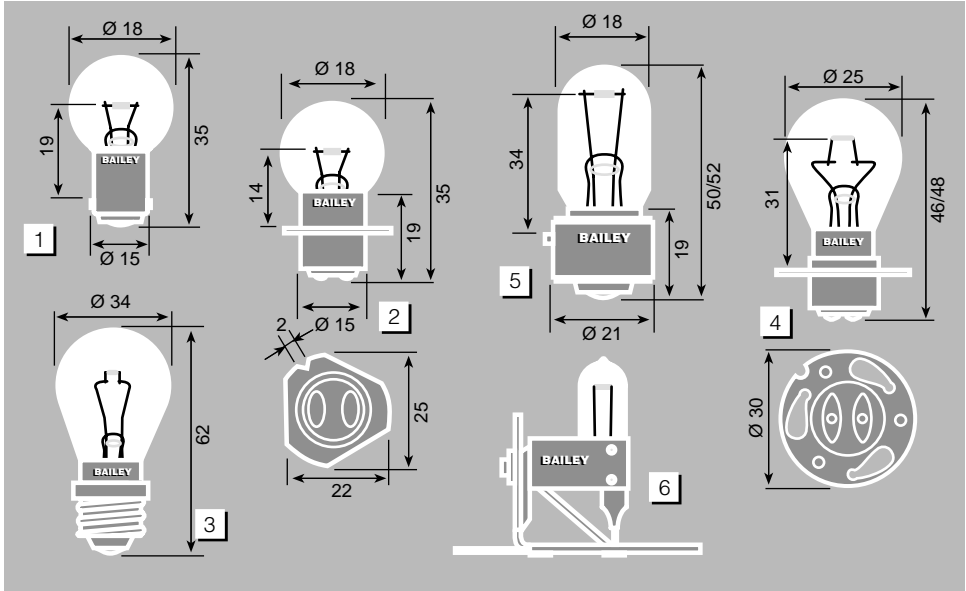

Description	Volt	Watt		Base	Life	Fig. no.	Type number
Olympus	6	15	2128X	Ba15s	100	1	MOL 8M102
Olympus	6	15	2129	P25d	50	2	MOL 21.29.15
Reichart	6	30		E19		3	MRE 91.569
Swift	6,5	2,75A	1460X Bausch & Lomb 31.31.43	P30d	100	4	MSW 760
Bausch & Lomb	20	1	1634	P30d	200	4	MBL 31.31.37
Wild	6	20		P21d	100	5	MWI 17.71.60
Wild	12	50			50	6	MWI 38.46.43

Other specifications on request.

Microscope lamps

Zeiss equivalents

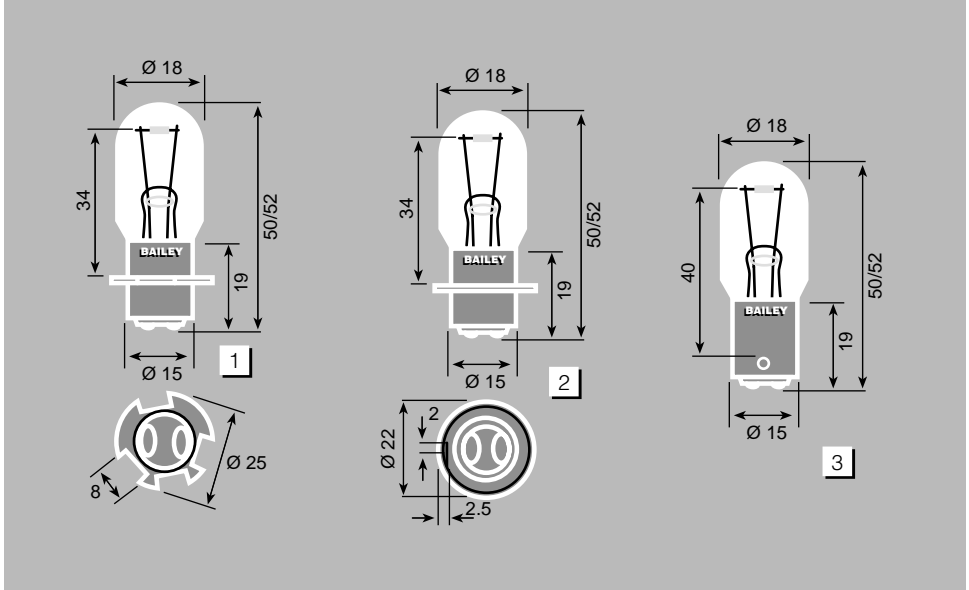

Description	Volt	Watt	Base	Life	Fig. no.	Type number
Zeiss	6	15	P22d	100	2	MZ 38.00.18.17.30
Zeiss	6	15	P25d/4	100	1	MZ 38.00.18.17.40
Zeiss	6	15	Ba15d/19		3	MZ 38.00.29.90.20
			Nikon 76906 Leitz 500-012 Wild 166324			

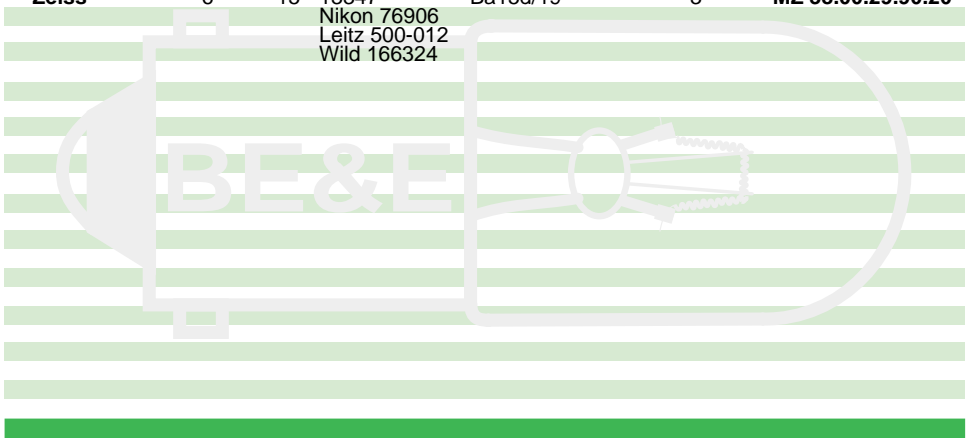

Other specifications on request.

Microscope lamps Zeiss Equivalents

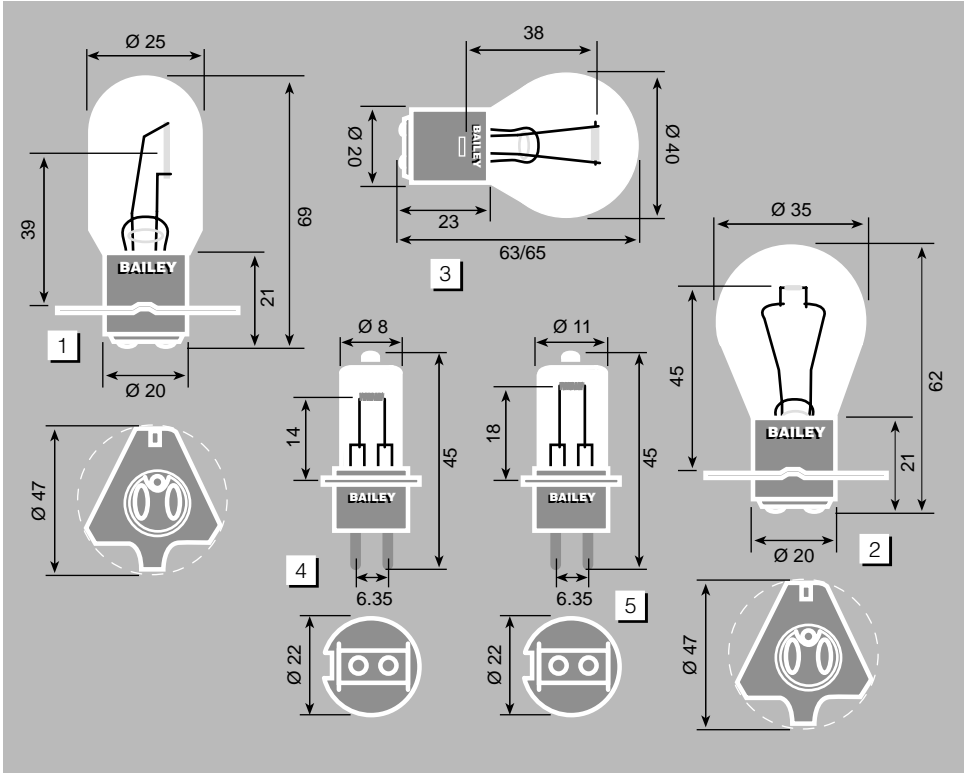

Description	Volt	Watt.		Base	Life	Fig. no.	Type number
Zeiss	6	30		P47d	100	2	MZ 39.01.58
Zeiss	6	50		P47d	120	2	MZ 39.01.86
Zeiss	6	25		P47d	100	1	MZ 39.01.53
Zeiss	12	60	Leitz 500-100	Ba20d	100	3	MZ 38.00.18.25.20
Zeiss	6	10	64222	PG22	300	4	MZ 38.01.20.07.030
Zeiss	12	30	64260	PG22	50	4	MZ 38.01.20.70.040
Zeiss	12	100	64626	PG22	50	5	MZ 38.00.75.10.20

Other specifications on request.

Microscope lamps

Silver side mirror

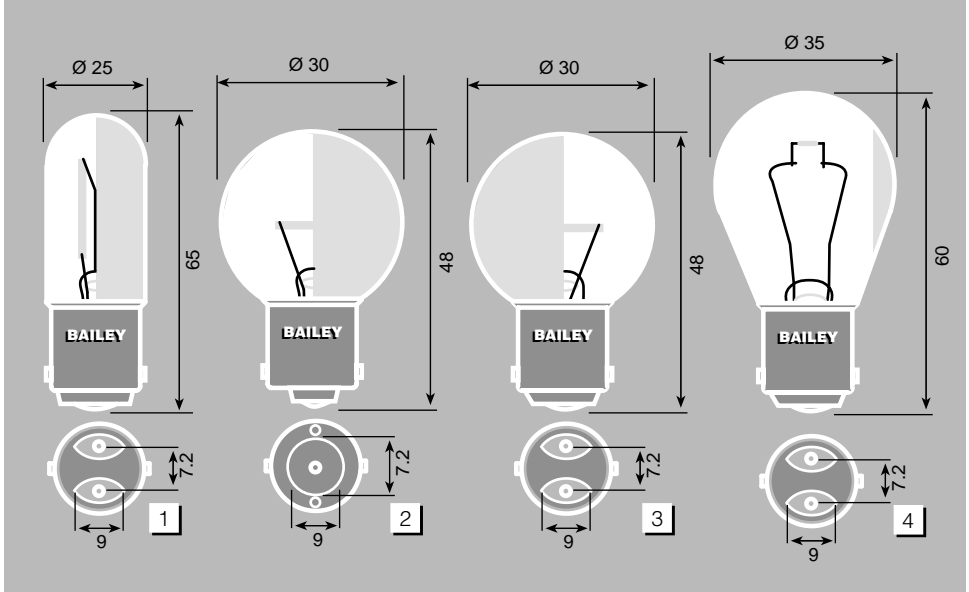

Volt	Watt	Base	Life	Fig. no.	Type number
12	40	Ba15s	200	2	P 012.0040.36031
120	30	Ba15d	200	4	P 120.0030.3609
220	20	Ba15d	300	3	P 220.0020.3601
220	30	Ba15d	300	1	P 220.0030.3602



Other specifications on request.

Medical lamps Exciter lamps

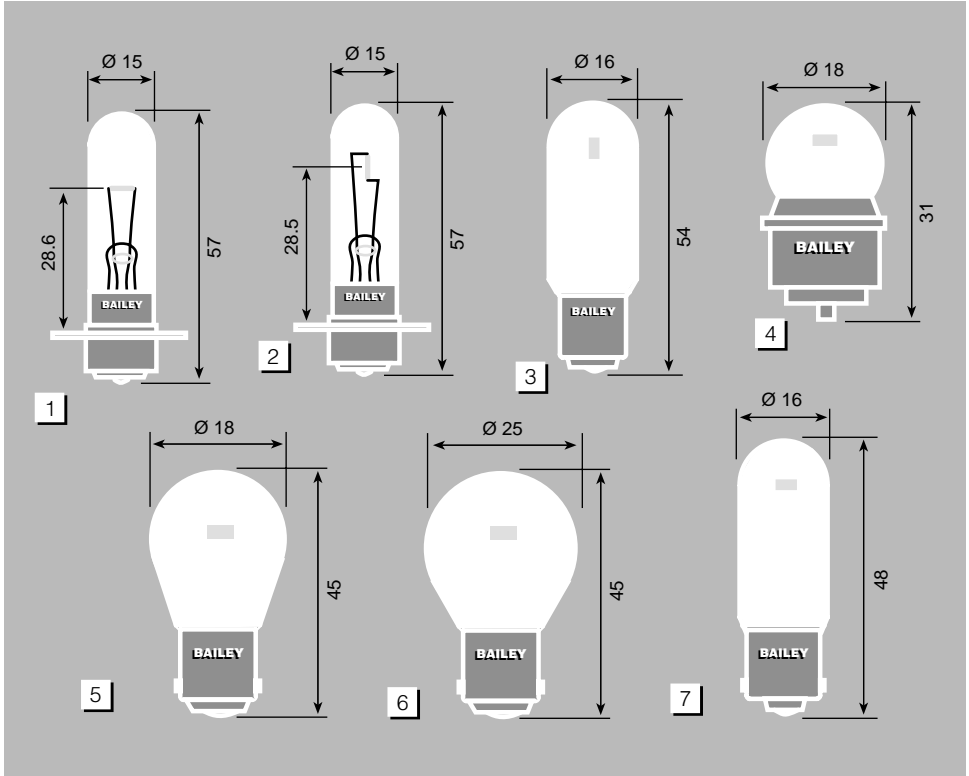

Volt	Watt	Base		Life	Fig. no.	Type number
4	0,75A	P30s	8004	50	1	P 004.0003 BRS
4	0,75A	P30s	8005	50	2	P 004.0003 BRK
4	0,75A	SX15s	8534	1000	3	P 004.0003.8534
6	4	souder	8412	1000	4	P 006.0004.8412
6	5	Ba15d	8510	1000	5	P 006.0005.8510
6	5	Ba15d	8512	800	6	P 006.0005.8512
6	5	Ba15d	8511	4000	6	P 006.0005.8511
6	5	Ba15s	8509	1500	7	P 006.0005.8509
6	5	Ba15s	8513	800	7	P 006.0005.8513

Other specifications on request.

Medical lamps

Exciter lamps

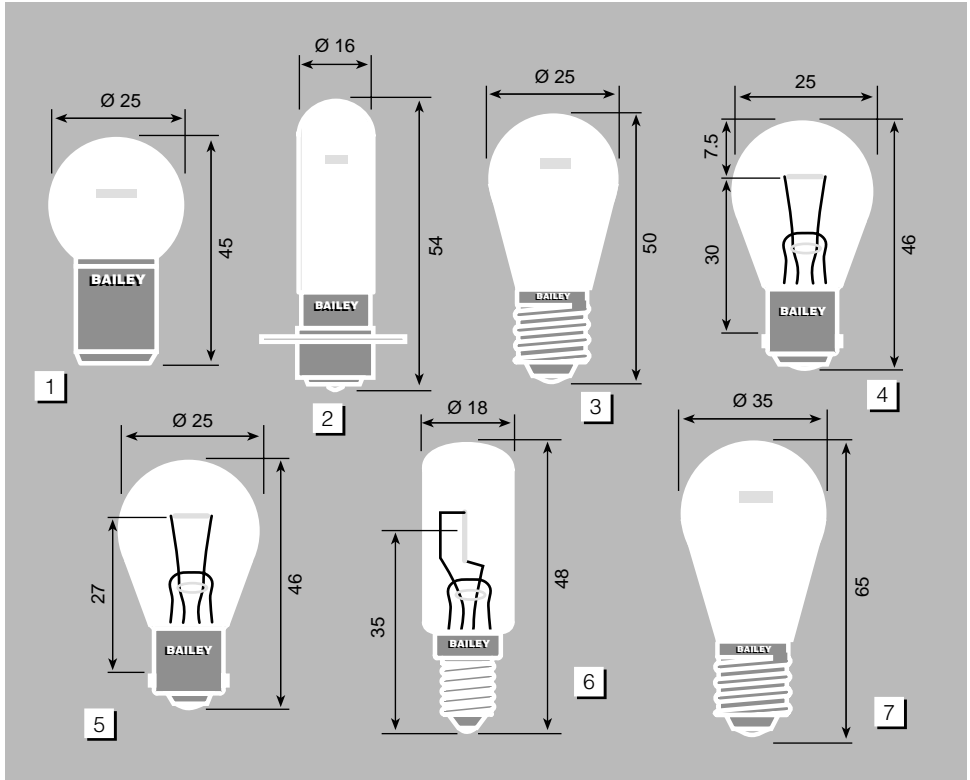

Volt	Watt	Base	Life	Fig. no.	Type number	
6	1A	Ba21-plain	2917	200	1	P 006.0006.2917
12	0,5A	Ba21-plain	2918	200	1	P 012.0006.2918
6	1A	P30s	8536	150	2	P 006.0006.8536
6	1,4A	E14	8411	1500	3	P 006.0008.8411
6	10	Ba15d	8013	200	4	P 006.0010.8013
6	10	Ba15s	8014	600	5	P 006.0010.8014
6	11	E10	18000	200	6	P 006.0011.18000
6	2A	E14	8507	300	7	P 006.0012.8507

Other specifications on request.

Medical lamps Exciter lamps

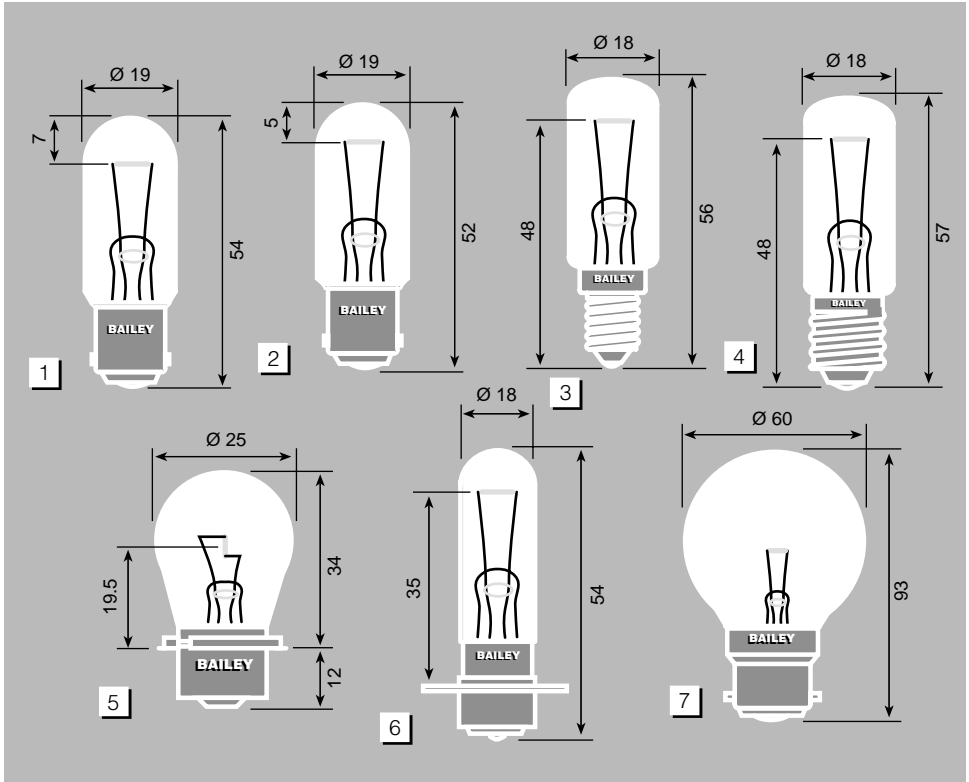

Volt	Watt	Base	Life	Fig. no.	Type number	
6	15	Ba15d	8017	1000	1	P 006.0015.8017
6	15	Ba15d	8018	100	2	P 006.0015.8018
6	15	E10	18023	200	3	P 006.0015.18023
6	15	E14	7768	100	4	P 006.0015.7768
6	15	P26s	7130	100	5	P 006.0015.7130
6	15	P30s	7931	100	6	P 006.0015.7931
6	100	B22d	13105B	100	7	P 006.0100.F40

Other specifications on request.

Medical lamps

Exciter lamps

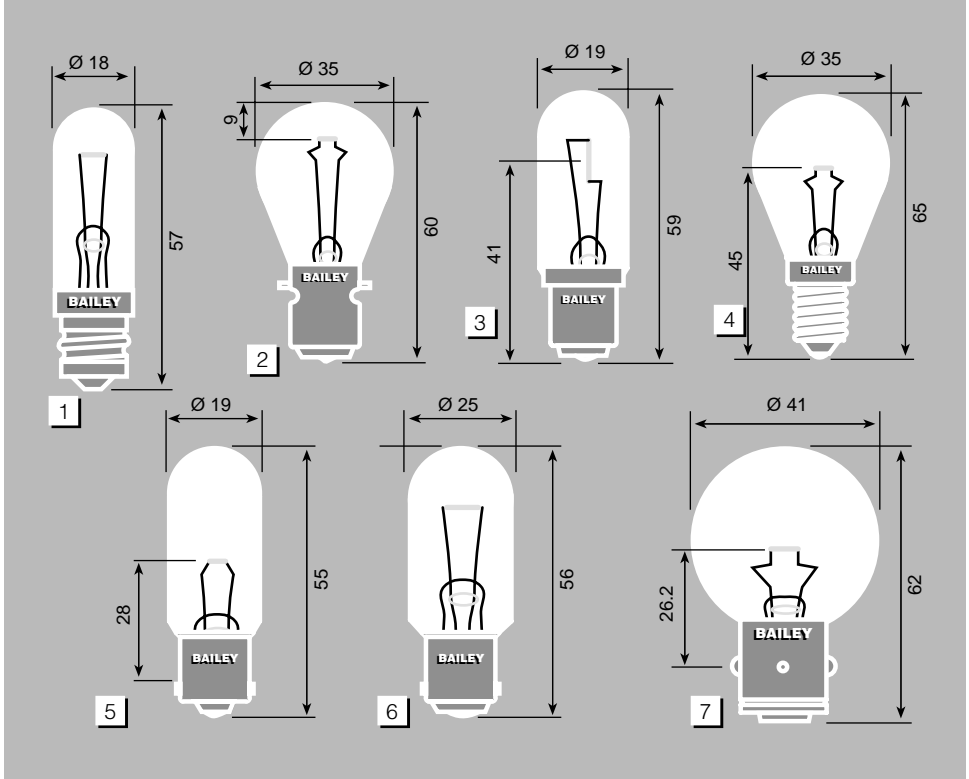

Volt	Amp.	Base	Life	Fig. no.	Type number	
6	15W	special screw	7242	100	1	P 006.0015.67273
6	5	Ba20d	8025	300	2	P 006.0030.8025
6	5	SX15s	8027	100	3	P 006.0030.8027
6	5	E14	8100	600	4	P 006.0030.8100
6	5	Ba15s	8128	50	5	P 006.0030.8128
6	5	Ba15d	2118	200	6	P 006.0030.2118
6	5	Ba21s	6717	300	7	P 006.0030.6717
12	5	Ba21s	7029	100	7	P 012.0060.7029

Other specifications on request.

Medical lamps Exciter lamps

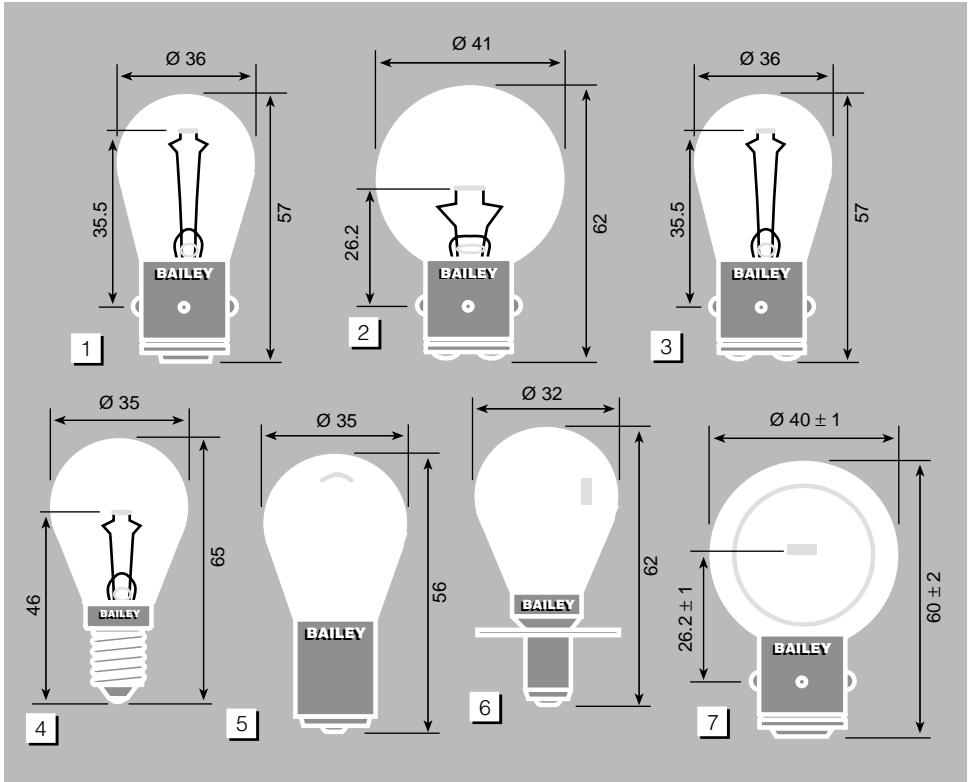

Volt	Amp.	Base	Life	Fig. no.	Type number	
6	5	Ba21s	6787	300	1	P 006.0030.6787
6	5	Ba21d	6732	300	2	P 006.0030.6732
6	5	Ba21d	6790	300	3	P 006.0030.6790
6	5	E14	6745	300	4	P 006.0030.6745
6	5	S20s	8514	100	5	P 006.0030.8514
6	5	H9,5s	8515	1000	6	P 006.0030.8515
6	5	Ba21s	7782	100	7	P 006.0030.7782

Other specifications on request.

Medical lamps

Exciter lamps

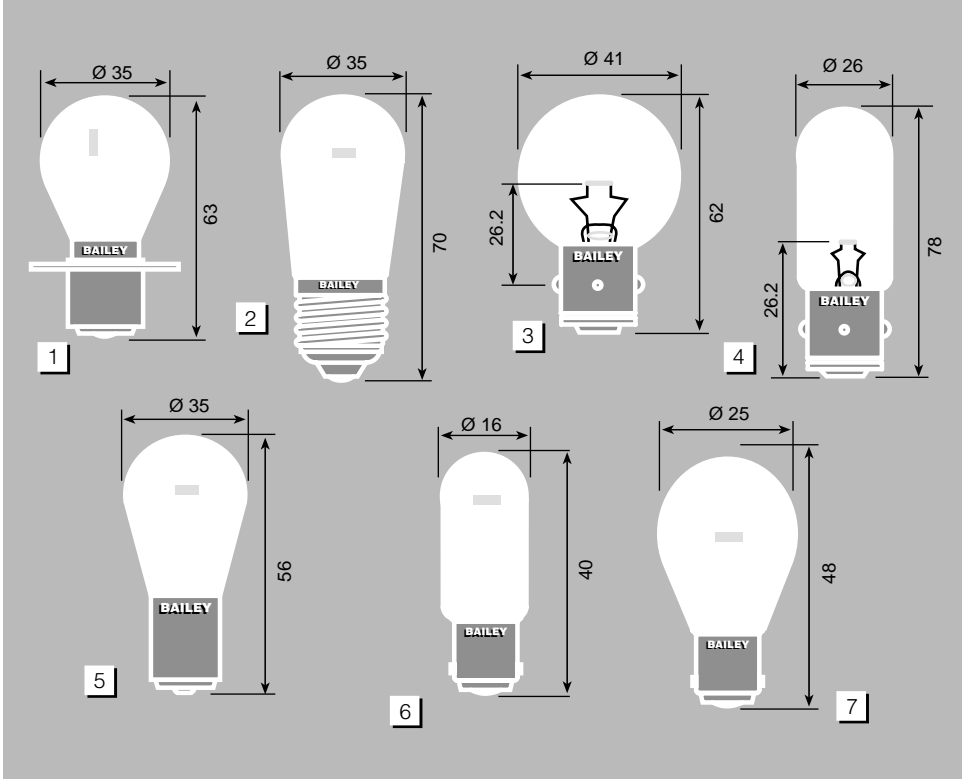

Volt	Watt	Base	Life	Fig. no.	Type number	
6	48	P30s	8535	200	1	P 006.0048.8535
6	48	E27	8533	200	2	P 006.0048.8533
6	10A	Ba21s	7579	50	3	P 006.0060.7579
6	10A	Ba21s	7582	100	4	P 006.0060.7582
6	30	S20s	8531	100	5	P 006.0030.8531
6	50	S20s	8436	100	5	P 006.0050.8436
6,3	5	Ba15d	8413	1500	6	P 006.0005.8413
6,5	1,4A	Ba15s	8410	800	7	P 006.0008.8410

Other specifications on request.

Medical lamps Exciter lamps

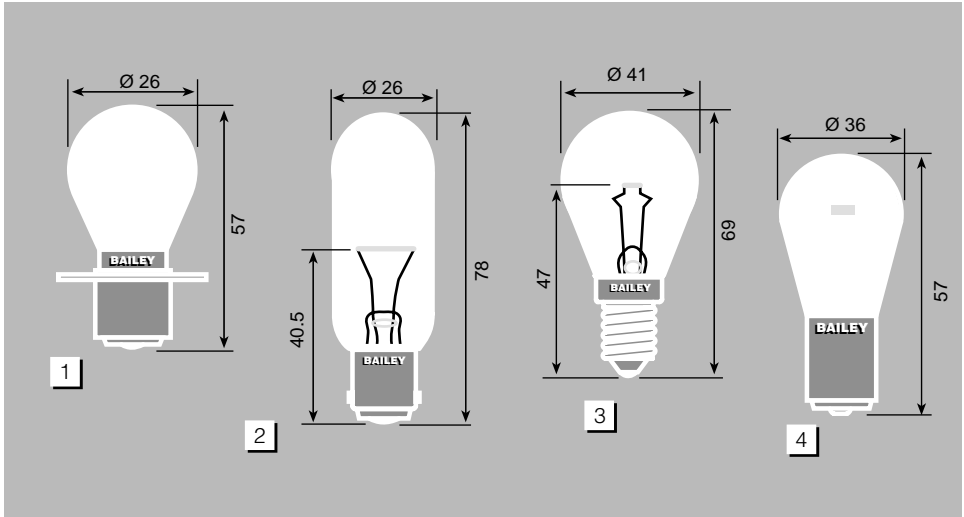

Volt	Amp.	Base		Life	Fig. no.	Type number
6,2	0,25	P30s	8458	1.000	1	P 006.0001.8458
6,2	0,46	P30s	8459	1.000	1	P 006.0003.8459
6,2	0,7	P30s	8460	1.000	1	P 006.0004.8460
6,2	0,92	P30s	8461	1.000	1	P 006.0006.8461
6,2	1,42	P30s	8462	1.000	1	P 006.0009.8462
12	0,25	P30s	8463	1.000	1	P 012.0003.8463
12	0,55	P30s	8464	1.000	1	P 012.0007.8464
12	0,77	P30s	8465	1.000	1	P 012.0009.8465
12	1	P30s	8466	1.000	1	P 012.0012.8466
12	1,15	P30s	8467	1.000	1	P 012.0014.8467
12	1,35	P30s	8468	1.000	1	P 012.0016.8468
12	1,9	P30s	8469	1.000	1	P 012.0023.8469
12	2,03	P30s	8470	1.000	1	P 012.0024.8470
12	3	P30s	8471	1.000	1	P 012.0036.8471
12	3,05	P30s	8472	1.000	1	P 012.0037.8472
12	5	P30s	8473	1.000	1	P 012.0060.8473
8	4	Ba15s	6501	400	2	P 008.0032.6501
10	5	Ba15s	6950	300	2	P 010.0050.6950
8	6	E14	7045	100	3	P 008.0048.7045
10	20W	Ba20s	8437	15000	4	P 010.0020.8437
10	30W	Ba20s	8438	15000	4	P 020.0030.8438

Other specifications on request.

Medical lamps

Exciter lamps

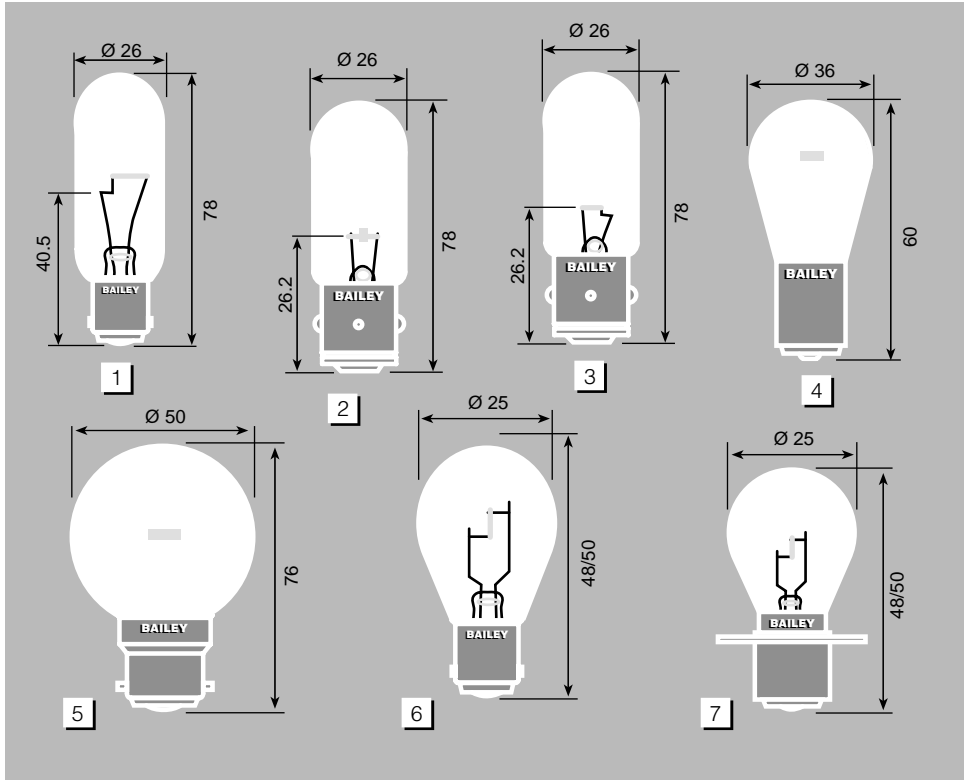

Volt	Watt	Base	Life	Fig. no.	Type number	
10	7,5A	Ba15s	7322	300	1	P 010.0075.7322
10	7,5A	Ba21s	7449	50	2	P 010.0075.7449
10	7,5A	Ba21s	7369	300	3	P 010.0075.7369
12	6	B22d	8484	600	4	P 012.0006.8484
12	24	B22d	8426	2000	5	P 012.0024.8426
12	25	Ba15s	7582	200	6	P 012.0025.7582
12	25	P30s	7582X	200	7	P 012.0025.7582X

Other specifications on request.

Medical lamps Exciter lamps

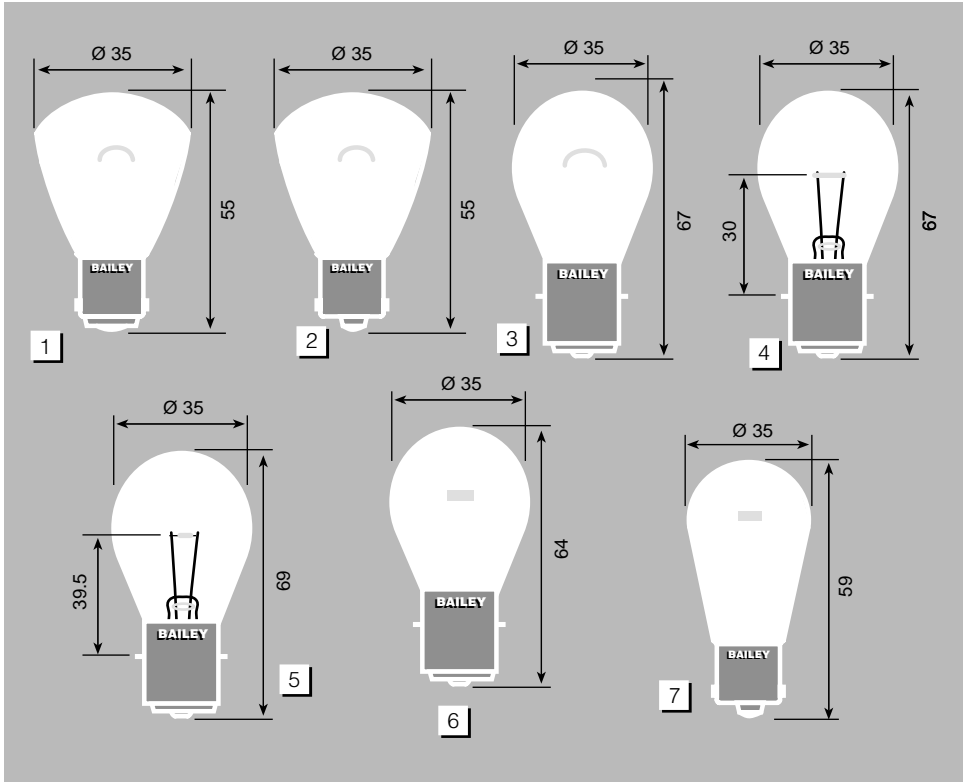

Volt	Watt	Base	Life	Fig. no.	Type number	
12	35	Ba15d	8423	200	1	P 012.0035.8423
12	35	Ba15s	9412	100	2	P 012.0035.9412
12	50	Ba20s	9416	200	3	P 012.0050.9416
12	40	Ba20d	8024	500	4	P 012.0040.8024
15	60	Ba20d	8029	100	4	P 015.0060.8029
12	50	Ba20d	8022	50	5	P 012.0050.8022
12	60	Ba20d	8557	100	6	P 012.0060.8557
12	5A	Ba15s	8542	100	7	P 012.0060.8542

Other specifications on request.

Medical lamps

Exciter lamps

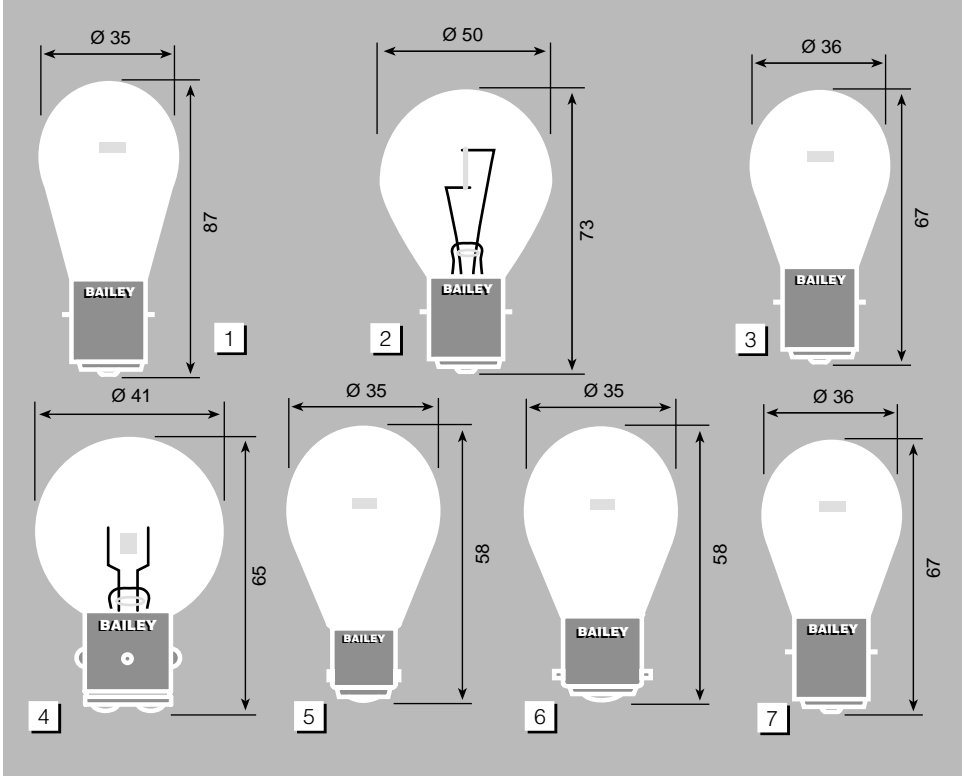

Volt	Watt	Base	Life	Fig. no.	Type number	
12	100	Ba20d	9421	100	1	P 012.0100.9421
12	100	Ba20d	9427	100	2	P 012.0100.9427
12	10/10	Ba20d	8487	600	3	P 012.0010.8487
12	20/20	Ba20d	8488	600	3	P 012.0020.8488
12	30/30	Ba20d	8489	600	3	P 012.0030.8489
16	8A	Ba21d	6144F	25	4	P 016.0128.6144F
24	25	Ba15d	9433	100	5	P 024.0025.9433
24	25	B22s	9431	100	6	P 024.0025.9431
24	35	Ba20d	9418	100	7	P 024.0035.9418

Other specifications on request.

Medical lamps Exciter lamps

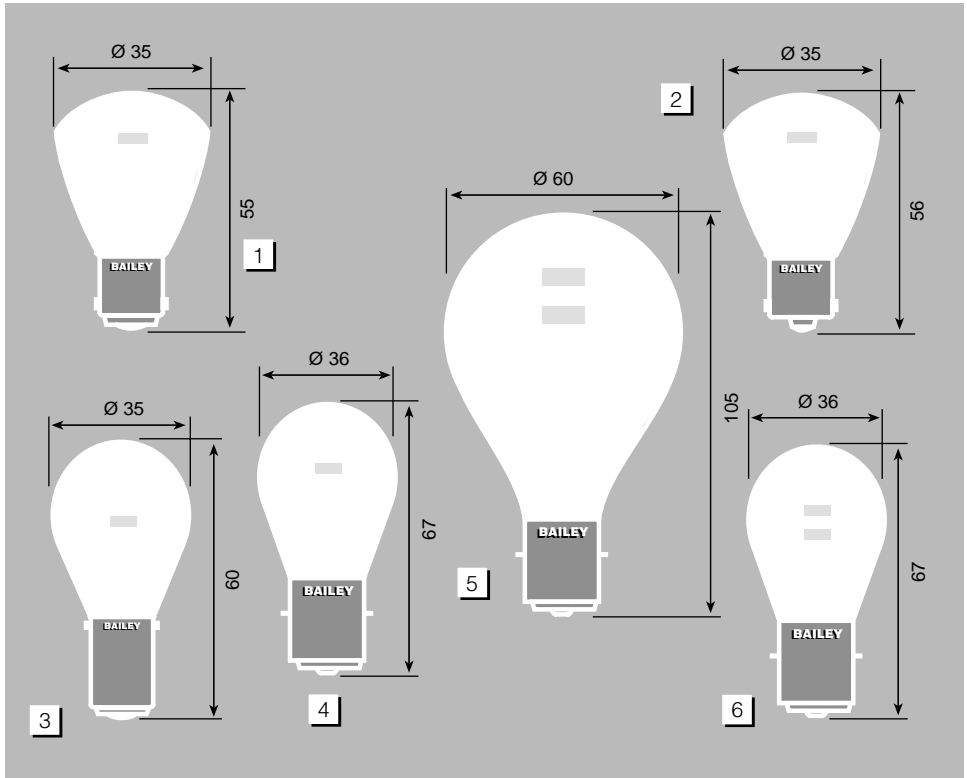

Volt	Watt	Base	Life	Fig. no.	Type number	
24	35	Ba15d	9438	300	1	P 024.0035.9438
42	50	Ba15s	9452	400	1	P 042.0050.9452
24	35	Ba15s	9417	100	2	P 024.0035.9417
24	50	Ba15s	9415	100	2	P 024.0050.9415
24	35	BX22d	8424	1500	3	P 024.0035.8424
24	100	Ba20d	9445	1000	4	P 024.0100.9445
45	45	Ba20d	9455	1000	4	P 045.0045.9455
24	60/60	Ba20d	8493	2000	5	P 024.0060.8493
24	60/60	Ba20d	8447	600	6	P 024.0060.8447
40	25/25	Ba20d	8480	8000	6	P 040.0025.8480
40	40/40	Ba20d	8481	8000	6	P 040.0040.8481
40	60/60	Ba20d	8482	8000	6	P 040.0060.8482

Other specifications on request.



Medical lamps

Exciter lamps

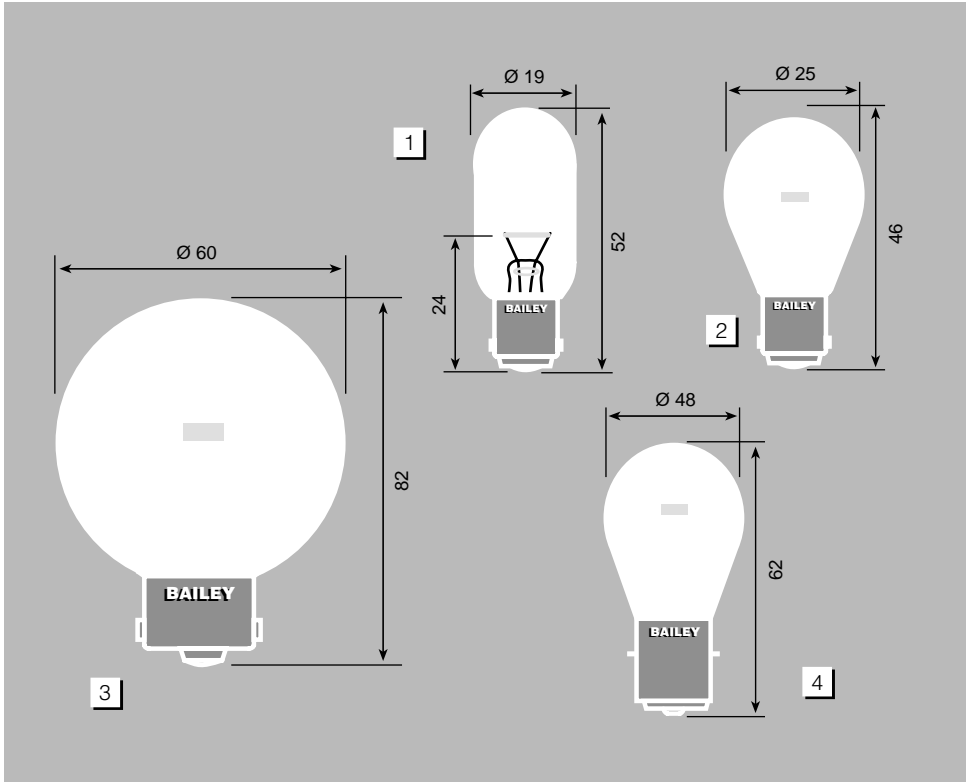

Volt	Watt	Base	Life	Fig. no.	Type number	
25	1A	Ba15s	8023	30	1	P 025.0025.8023
30	10	Ba15s	8421	1000	2	P 030.0010.8421
30	15	Ba15s	8422	800	2	P 030.0015.8422
30,3	200	B24s	8420	200	3	P 030.0200.8420
40	20	Ba20d	8425	2000	4	P 040.0020.8425

Other specifications on request.